

Keilrippenscheiben für Taperbuchsen nach DIN 7867 - technische Daten Poly-V Pulleys for Taper Bushes according to DIN 7867 - Technical Data

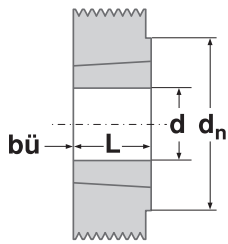

Ausführung
Type 1

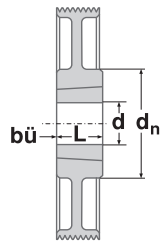

Ausführung
Type 2

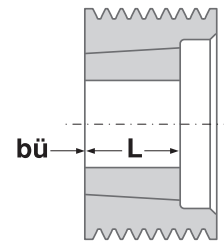

Ausführung
Type 3

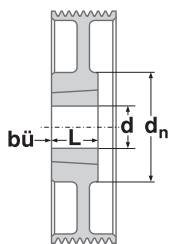

Ausführung
Type 4

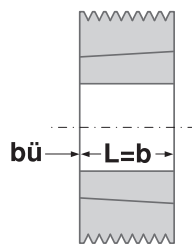

Ausführung
Type 5

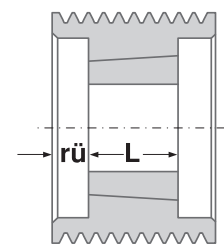

Ausführung
Type 6

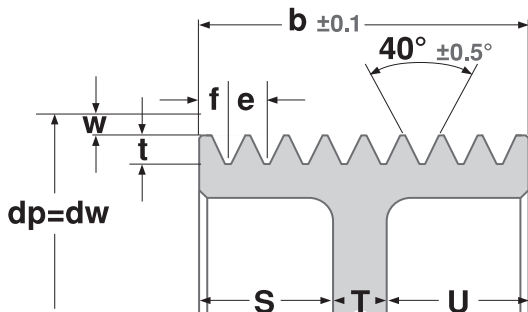

Maße Dimensions	Profil Section	
	J	L
e =	2,34	4,70
e +/-	0,03	0,05
f min	1,80	3,30
t min	2,08	4,98
t max	2,34	5,23
2w	2,5	5

Ausführung/ type: ● Vollscheibe/ Solid pulley
○ Bodenscheibe/ Plate pulley

b_ü = bündig
sym = symmetrisch
r_ü = rückspringend